

AIR TURBINE SPINDLE

Operation manual

RBX5 · RBX5C
RBX7 · RBX7C

Please be sure to read this manual before using the product



● INDEX ●

■ SAFETY NOTES	P 1	5. Air nozzles adjustment	P 8
■ INTRODUCTION	P 2	6. Pull-stud bolts installation	P 8
■ SPECIFICATIONS	P 3	■ INSTALLATION	
■ UTILIZATION PROCEDURES		1. Installation of the side through type	P 9
1. How to install / remove a cutting tool	P 3	2. Installation of the center through type	P15
2. Initial rotation of the AIR TURBINE SPINDLE	P 6	3. Installation of the manual type	P16
3. Spindle speed adjustment	P 6	4. Concerning the air supply	P17
4. Concerning the use of coolants	P 7	■ OTHER	P19



SAFETY NOTES

The following safety notes are arranged in order to use correctly our product and to protect the operator and other people from possible injuries and damages. In order to distinguish the severity of the injury or damage, the safety notes are divided in three categories “Caution”, “Warning” and “Danger”. Please be sure to respect the safety notes since any of them contain important safety matters.

-  **CAUTION** : This note indicates that the wrong handling of the product may injury people or cause material damages.
-  **WARNING** : This note indicates that the wrong handling of the product may cause death or severe injuries.
-  **DANGER** : This note indicates a dangerous situation that if not avoided may cause death or severe injuries.



DANGER

- Since the AIR TURBINE SPINDLE rotates at very high speed, if the cutting tool breaks during the process its fragments, scattering, will cause an extremely dangerous situation. During the process, utilize a safety cover, etc. in case that fragments scatter out and please also take enough safety measures for protect yourself. In addition, please always wear protective eyeglasses.
- Do not rotate the machine spindle when the AIR TURBINE SPINDLE is installed on the machine. (In case of utilizing the manual type, the machine spindle, by turning, may twist the air tube and cause severe accidents.)
- ※ A low speed rotation for few seconds to orientate the side through type is not a problem.



WARNING

- Do not touch the cutting tool or the chuck part while the spindle is rotating.
- Do not touch the holder rotating part immediately after have stopped the air supply. (The holder rotating part will rotate by inertia even after have stopped the air supply. Please check that the rotating part is not moving in case of touching it.)



CAUTION

- Please reduce the ATC speed. (The impact with the ATC may damage the cutting tool in case of using tools with small diameter.)

Please also respect the below notes in case of using the center through type (RBX5C, RBX7C).



CAUTION

- Do not use it on machines that have previously used coolants, oil mists, etc. (Foreign bodies invading the holder may reduce its lifespan or cause breakages.)
- In case of using BBT, BCV and BDV shanks, please use pull-stud bolts provided with holes (sold apart).

INTRODUCTION



In order to be able to use the AIR TURBINE SPINDLE, it is necessary to install the machine tool, air supply, etc. Please consult the below **INSTALLATION** and conduct the installation correctly.

SPECIFICATIONS

About the specifications

1 Specifications P3

INSTALLATION

About the installation on the machine tool and the air supply

1 Installation of the side through type
P9 – P14

2 Installation of the center through type
P15

3 Installation of the manual type
P16

4 Concerning the air supply P17

UTILIZATION PROCEDURES

About the process, the cutting tool installation, the air adjustments, etc

1 How to install / remove a cutting tool P3 – P5

2 Initial rotation of the AIR TURBINE SPINDLE P6

3 Spindle speed adjustment P6

4 Concerning the use of coolants P7

5 Air nozzles adjustment P8

6 Pull-stud bolts installation P8

OTHER

About the storage, maintenance

1 Long period storage and re-use P19

2 Maintenance P19

SPECIFICATIONS

1 Specifications

Type	RBX5 / RBX5C	RBX7 / RBX7C
Maximum spindle speed	About 50,000min ⁻¹ (0.6MPa)	About 80,000min ⁻¹ (0.6MPa)
Minimum spindle speed	About 40,000min ⁻¹ (0.3MPa)	About 60,000min ⁻¹ (0.3MPa)
Air pressure	0.3 – 0.6 MPa	
Air flow rate	300 L /min [ANR] (0.6 MPa)	
Tool diameter	ø1.5mm or smaller	ø1.0mm or smaller
Clamping diameter	ø0.45 – 4.05mm	
Collet model	NBC4S-dAA(Optional)	

UTILIZATION PROCEDURES

1 How to install / remove a cutting tool

Use the X-Wrench and the Mega Wrench for install / remove the cutting tool.

[Collet installation procedures]

Insert the collet from the rear part of the nut and push it until the ribbed part of the collet is set with a “click”.

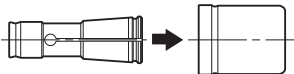

[Collet removal procedures]

It is possible to remove the collet from the nut by pulling the collet straight along the spindle.

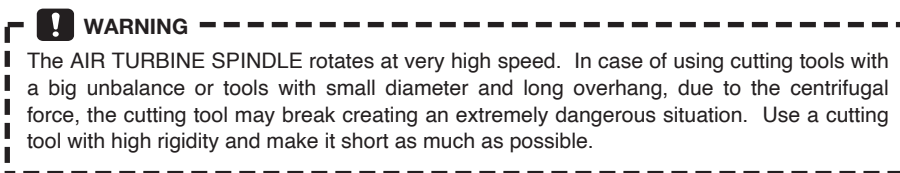
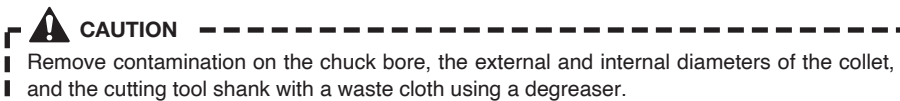
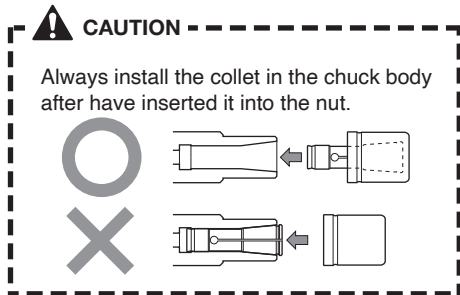

[How to install a cutting tool]

- ① Insert the cutting tool in the collet – nut and tight it lightly with your hands. Reduce the overhang of the cutting tool as much as possible. (It greatly influences the T.I.R. and Rigidity.)

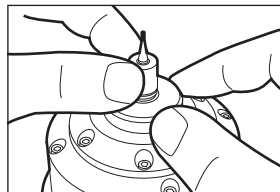

- ② Let project a little bit both side-lock screws of the X-Wrench, shift the handle on the "LOCK" side and move the handle to the left as shown in the picture FIG 2. Then insert the wrench on the flange part of the spindle and lock the spindle by moving the handle.

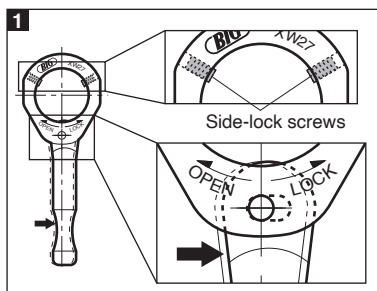

Let project a little bit both side-lock screws and shift the handle on the "LOCK" side.

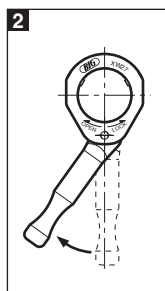

Shift the handle as shown in the picture.

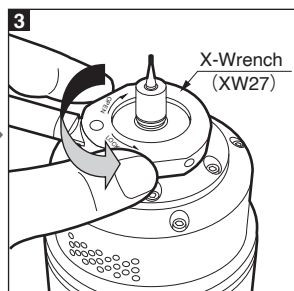

Insert the wrench on the flange part of the spindle and move it on the "LOCK" side.

How to use X-Wrench (XW27)

The X-Wrench is a wrench that secures the spindle of the AIR TURBINE SPINDLE when tightening the collet. It clamps the spindle thanks to the eccentric cam structure of the handle. Please adjust the 2 side-lock screws if it is not possible to lock.

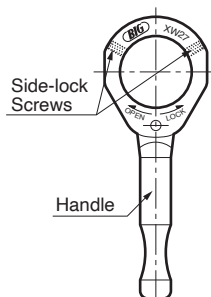

When the wrench is inserted in the spindle

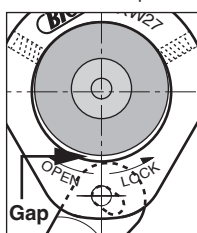

When the nut is tighten

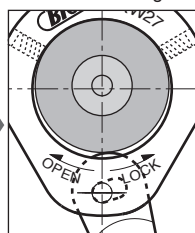

The spindle's flange is secured thanks to the side-lock screws and to the handle's tip.

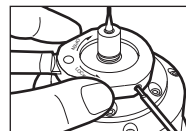

Please adjust the side-lock screws on the wrench if it is not possible to lock.

- ③ Insert the MEGA Wrench on the nut with the “LOCK” seal facing up and execute the tightening process with both hands. (Recommended tightening torque: 3N·m)

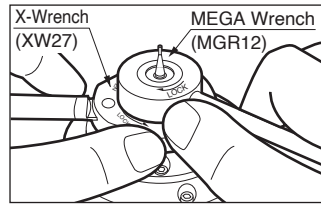

※After mounting the cutting tool, check the runout at the tool shank base. (Minimize the runout at the tool shank base, within 1μm as a guideline.)

CAUTION

- Be careful not to damage the cutting tool when inserting the wrench.
- Handle the wrenches horizontally. If a force is applied in the axis direction, the spindle's bearings will endure a great load that may rapidly decrease the lifespan of the spindle.
- When clamping the cutting tool, excessive torque may deteriorate the runout accuracy or damage the collet or nut.

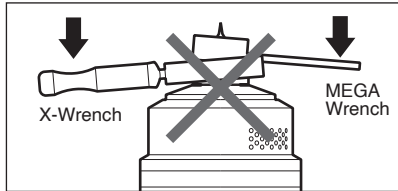

[How to remove a cutting tool]

To remove a cutting tool, invert “LOCK” and “OPEN” and unfasten the nut with both wrenches following the same procedures.

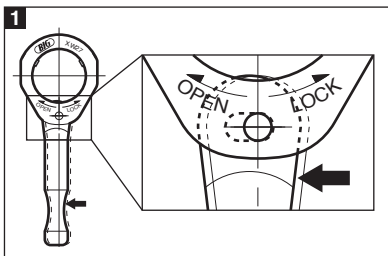

Shift the handle to the “OPEN” side.

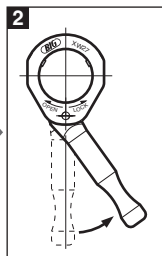

Shift the handle as shown in the picture.

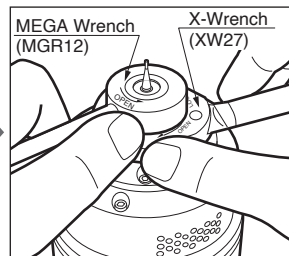

2 Initial rotation of the AIR TURBINE SPINDLE

[Warming-up operation]

It is recommended to execute a warming-up operation to lubricate with grease the internal parts of the bearings when the unit is used for the first time or if the unit is not used for more than 1 week. Perform the warming-up operation according to the air pressure indicated on the table.

Air pressure for the warming-up operation	0.3MPa
Warming-up time	More than 10 min.

[Acceleration time]

After have started the air supply, it is necessary to wait several seconds to reach the selected speed.

Start the process according to the time indicated on the table. (The table indicates the time required to reach the target speed after have adjusted the air pressure and started the air supply.)

Target speed (min ⁻¹)		Time required for reaching the target speed
RBX5/RBX5C	RBX7/RBX7C	
40,000	60,000	30 sec.
45,000	70,000	25 sec.
50,000	80,000	20 sec.

CAUTION

Never touch a rotating spindle or cutting tool: this is very dangerous.

3 Spindle speed adjustment

It is possible to adjust the speed of the AIR TURBINE SPINDLE by controlling the air pressure with a regulator. Please consult the below table. (The values indicated in the below table are reference values. Depending on the model, the speed may differ by 5%.)

Please refer to the table indicating the air pressure and the spindle speed on the body of the AIR TURBINE SPINDLE.

Air pressure (MPa)	Spindle speed (min ⁻¹)	
	RBX5/RBX5C	RBX7/RBX7C
0.30	38,000	58,000
0.35	40,000	62,000
0.40	43,000	66,000
0.45	45,000	70,000
0.50	47,000	73,000
0.55	48,500	77,000
0.60	50,000	80,000

CAUTION

The air pressure should be above 0.3MPa.
If the air pressure is low, the torque will be insufficient and the process unstable.

4 Concerning the use of coolants

While no air is supplied to the AIR TURBINE SPINDLE body, air purge does not function and coolant may intrude into the interior. To avoid this, follow the procedures below and turn on / off the air and coolant supply to the AIR TURBINE SPINDLE.

[When rotation starts]

AIR TURBINE SPINDLE air supply ON → Coolant / Oil mist ON

[When rotation stops]

Coolant / Oil mist OFF → AIR TURBINE SPINDLE air supply OFF

⚠ CAUTION

Pay attention not to apply the coolant directly on the AIR TURBINE SPINDLE. In particular do not apply the coolant on the air vents and on the gap between the case and the flange of the spindle. Coolant may intrude into the interior and reduce the lifespan of the bearings.

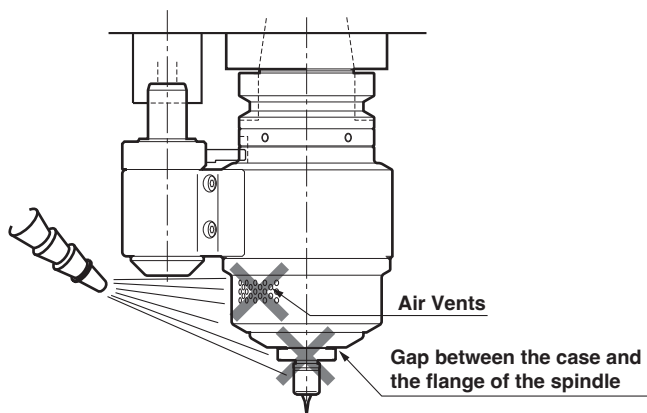

5 Air nozzles adjustment

The direction of the air nozzles can be set in 4 directions at 90° each. If, due to the emitted air, the application of the coolant is inadequate, please follow the below procedures to adjust the direction of the air nozzles.

- ① Loosen the 4 fixing bolts of the muffler case.
(Refer to the below safety notes)
- ② Remove the 4 bolts.
- ③ Adjust the direction of the air nozzles by rotating the muffler case matching the positions of the bolts' holes.
- ④ Re-tight firmly the bolts.

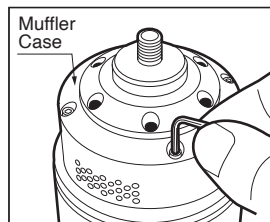

⚠ CAUTION

Do not loosen the 6 red-painted bolts. It may become cause of damages or worsen the accuracy.

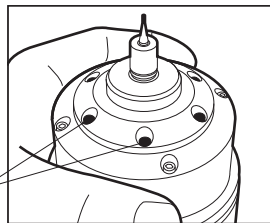

Never loosen the (6) bolts.

6 Pull-stud bolts installation

Follow the below procedures to install the pull-stud bolts.

- ① Check if the machine and the pull-stud bolts are compatible.
- ② Clean the installation holes of the taper and remove the grease of the pull-stud bolts.
- ③ Apply an anti-loosening solution. (Refer to the operation manual of the anti-loosening manufacturer for details regarding the application method.)
- ④ Always use the torque wrench (available on the market) and clamp following the below recommended torque.

BT No.	Tightening torque (N·m)
BBT30	15 – 20
BBT40	45 – 65
BBT50	85 – 115

⚠ CAUTION

Always respect the recommended torque when clamping the pull-stud bolts. In particular for BBT30, exceeding the recommended values will easily bulge the taper, due to the thickness of the small part of the taper. Since, when the AIR TURBINE SPINDLE is used, the spindle of the machine does not rotate, the clamping torque of the pull-stud bolts is a little lower than normal.

INSTALLATION

About BIG-PLUS (BBT, BDV, and BCV)

BIG-PLUS is a standard product of BIG Daishowa Seiki. Use machine tools with the BIG-PLUS trademark to obtain a correct double face contact. BIG-PLUS holders are also compatible with spindles of standard machines. In this case, check that there are not projecting objects in the machine spindle's surface and in the holder's surface.

1 Installation of the side through type

The AIR TURBINE SPINDLE is set and shipped following the machine model indicated at the moment of the purchase and consulting our past results. However, for safety reasons, be sure to check the following notes before the installation on the machining center.

1-1 ATC arm interference check

Use as base the interference values written in the operation manual of the machining center and the measures of K_1 and ϕD of the AIR TURBINE SPINDLE to check that there is no interference between the ATC arm of the machining center and the AIR TURBINE SPINDLE. Please inquiry the machine manufacturer in case of unclear interference.

《Side through type》

BBT shank

Shank Size	Type	K_1	ϕD
BBT30	RBX7	28	80
BBT40	RBX7	43	80
	RBX5		96
BBT50	RBX7	58	100
	RBX5		

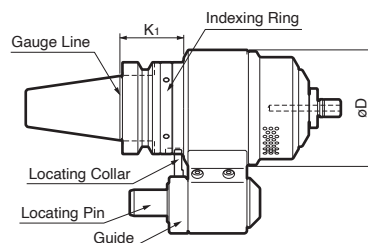

BCV, BDV shank

Shank Size	Type	K_1	ϕD
#40	RBX7	57	80
	RBX5		96
#50	RBX7	62	100
	RBX5		

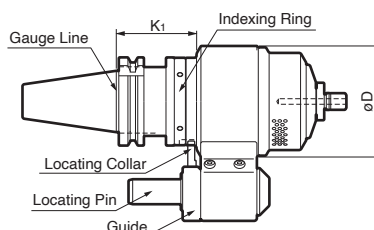

HSK shank

Shank Size	Type	K_1	ϕD
HSK-A63	RBX7	67	80
	RBX5		96
HSK-A100	RBX7	72	100
	RBX5		

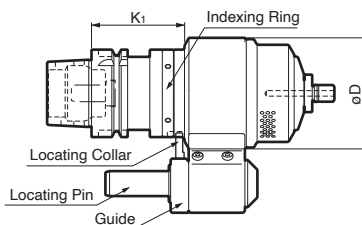

1-2 Locating block of the machine spindle

The locating block is necessary for the air supply. Since the measures and the shape of the locating block depend on the model of the machining center, control, by checking the operation manual, drawing and materials of the machine that the block is actually suitable for the machine's spindle.

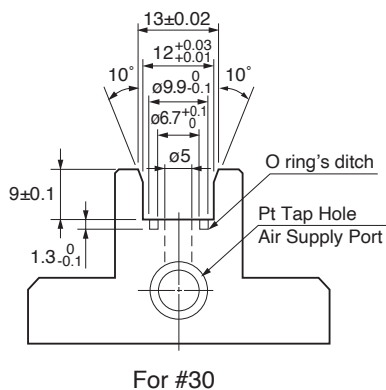
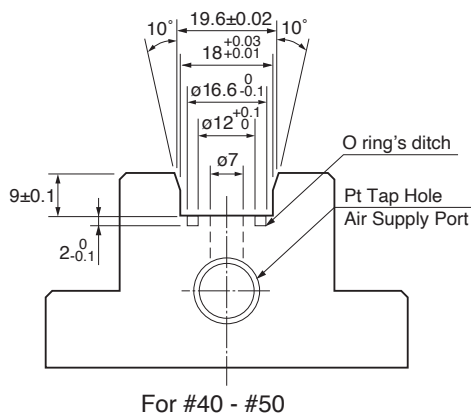

CAUTION

- A tap hole for plumbing laterally the air is always necessary for the locating block.
- When installing the air to the locating block, use an air filter. An air rich with moisture and foreign particles may damage the bearings.
- In case of using the ATC, before installing the AIR TURBINE SPINDLE release one time the air for clean the ditches and the internal parts of the block.

※To the customers that currently use our High Jet Holder, High Spindle, etc and have already installed the locating block in the machines

Even if the locating block for the AIR TURBINE SPINDLE and the locating block for the holder of the High Jet Holder, High Spindle, etc have the same shape, please avoid a shared use. In case of the AIR TURBINE SPINDLE, the air supplied from the locating pin has to be pure. If a locating block that has used in the past coolants, is used for the AIR TURBINE SPINDLE, the coolant invading the AIR TURBINE SPINDLE, may reduce its efficiency and life due rust, etc.

1-3 Settings check

Check that the setting measures of the "Inspection sheet" included with the AIR TURBINE SPINDLE match the values of the machine's spindle nose.

① **If the pitch S is different**

Please return the product to us since the modifications cannot be done by the customer.

② **If the setting length H is different**

Please read at P12 "How to adjust the setting length H " and proceed with the adjustments.

③ **If the setting angle θ is different**

Please read at P13 "How to adjust the setting angle θ " and proceed with the adjustments.

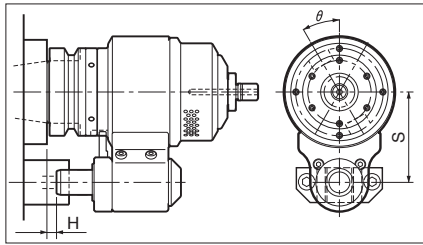

1-4 Checking by actual installing

After the orientation (M19) of the machining center's spindle, fix the drive key's position and install manually the AIR TURBINE SPINDLE on the machine. At this time check that the drive key and the locating pin enter without problems.

CAUTION

Be sure to do the checks when performing the manual installation. If there are errors in the settings, the AIR TURBINE SPINDLE may be damaged during the ATC.

1-5 Length settings check

Mount the AIR TURBINE SPINDLE into the machine spindle and confirm the actuating amount of the locating pin. The correct position has a gap of 2mm and 1mm on each side of the clutch. (See the figure on the right)

※ If the gaps differ, please read at P12 "How to adjust the setting length H " and proceed with the adjustments.

CAUTION

- When the actuating amount of the locating pin exceeds the prescribed 6 mm, it causes eccentric load to the case, applies abnormal load to the bearings and leads to heat generation and decreased service life.
- When the locating pin is not fully actuated to the prescribed amount, the locking mechanism is not released. If the machine spindle is rotated in this state, the AIR TURBINE SPINDLE may be damaged.

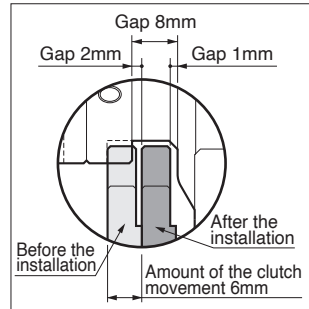

1-6 Regarding the ATC

Execute the ATC after have checked the procedures from 1-1 (P9) to 1-5 (P11) and the below attention notes.

CAUTION

- Please reduce the ATC speed. The impact with the ATC may damage the tool in case of using tools with small diameter.
 - Do not rotate the machine spindle while the AIR TURBINE SPINDLE mounted into the machine spindle. (This may cause malfunctions such as seizure.)
- ※ It is not a problem to rotate the machine's spindle for the orientation at the moment of the ATC.

► How to adjust the setting length H ◀

※ It is not possible to adjust the #30 type

① How to remove the locating pin

《#40, HSK-A63 types》

- Keeping pushed the locating pin (to release the lock mechanism), manually rotate the taper until the tip of the locating collar is located in the large notch of the indexing ring.
- Rotate the locating pin until it is positioned in the large notch of the indexing ring and pull it out. Also remove at the same time the locating collar and the spring.

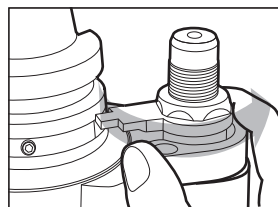

《#50, HSK-A100 types》

- As in the right figure, remove 2 stopper bolts with a hex key.

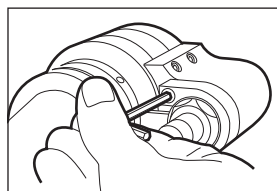

- As in the right figure, while depressing the locating pin, rotate the guide and remove the locating pin.

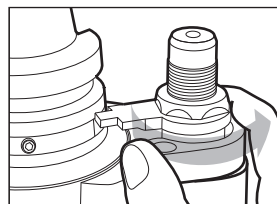

② How to calculate the length of the locating pin

Substitute the setting length H of the used machine with the following formula and calculate the length B of the locating pin.

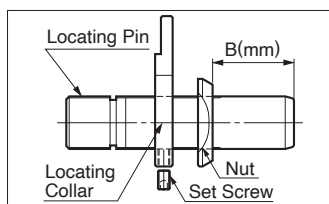

In case of BBT shanks

Shank size	Length of B
BBT40	$B(\text{mm}) = 32 - H$
BBT50	$B(\text{mm}) = 47 - H$

In case of BCV, BDV shanks

Shank size	Length of B
#40	$B(\text{mm}) = 46 - H$
#50	$B(\text{mm}) = 51 - H$

In case of HSK shanks

Shank size	Length of B
HSK-A63	$B(\text{mm}) = 56 - H$
HSK-A100	$B(\text{mm}) = 61 - H$

③ How to adjust the length of the locating pin

Loosen the set screw of the locating collar then loosen the nut and the locating collar itself. Adjust the nut and set the pin length to $B \pm 0.3\text{mm}$ (Refer to the above figure).

After the adjustment, fix the nut and tighten the locating collar. Apply the anti-loosening solution (Toagosei: Arontight US equivalent) to the set screw of the locating collar, insert a brass shim and tighten the screw completely with an L-wrench.

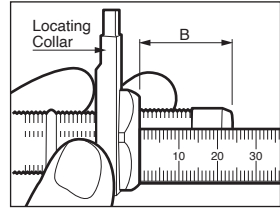

④ How to install the locating pin

Install the locating pin by inverting the removal procedures.

► How to adjust the setting angle θ ◀

《#40, #50 types》

① Side lock removal

Loosen the 4 lock bolts of the indexing ring.
(Refer to the figure on the right)

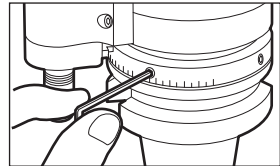

② Setting angle adjustment

Check that the indexing ring rotates around the circumference. Adjust the scale of the indexing ring to the setting angle θ used on your machine by matching exactly the line marker on the main body.
(Refer to the figure on the right)

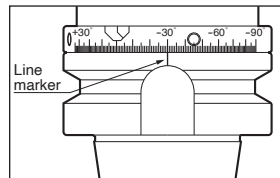

③ Tightening the side lock

After the adjustment, apply the anti-loosening solution (Toagosei: Arontight US equivalent) to the lock bolts and tighten firmly and uniformly the 4 lock bolts. In this moment, gradually clamp the 2 opposite locations.

⚠ CAUTION

If the 4 lock bolts are not uniformly and gradually clamped, the indexing ring will be loose causing ATC problems.

《#30type》

① Side lock removal

Loosen the 2 lock bolts of the indexing ring.
(Refer to the figure on the right)

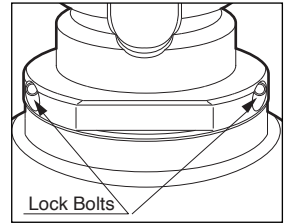

② Setting angle adjustment

Check that the indexing ring rotates around the circumference. Adjust the scale of the indexing ring to the setting angle θ used on your machine by matching exactly the line marker on the main body.

(Refer to the figure on the right)

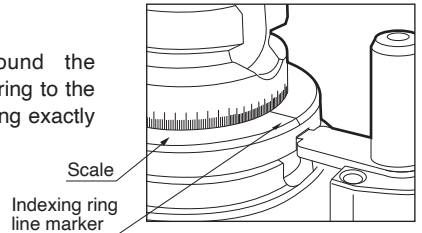

③ Tightening the lock bolts

After the adjustment, apply the anti-loosening solution (Toagosei: Arontight US equivalent) to the lock bolts and tighten firmly and uniformly the 2 lock bolts.

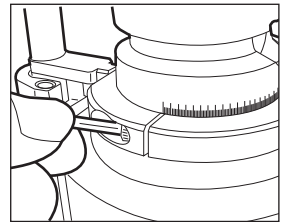

2 Installation of the center through type

For safety reasons, be sure to check the following notes before the installation on the machining center.

⚠ CAUTION

Do not use it on machines that have previously used coolants, oil mists, etc.
(Foreign bodies invading the holder may reduce its lifespan or cause breakages)

⚠ CAUTION

In case of using BBT, BCV and BDV shanks, please use pull-stud bolts provided with holes (sold apart).

2-1 ATC arm interference check

Use as base of the interference values written in the operation manual of the machining center and the measures of K_1 and ϕD of the AIR TURBINE SPINDLE to check that there is no interference between the ATC arm of the machining center and the AIR TURBINE SPINDLE. Please inquiry the machine manufacturer in case of unclear interference.

BBT shank

Shank size	Type	K_1	ϕD
BBT40	RBX7C	43	78
	RBX5C		96
BBT50	RBX7C	53	78
	RBX5C		96

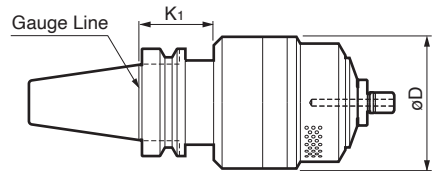

HSK shank

Shank size	Type	K_1	ϕD
HSK-A63	RBX7C	53	78
	RBX5C		96
HSK-A100	RBX7C	58	78
	RBX5C		96

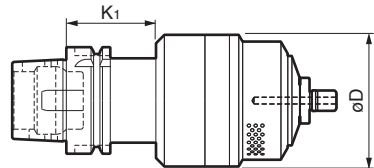

2-2 Regarding the ATC

⚠ CAUTION

- Please reduce the ATC speed. The impact with the ATC may damage the tool in case of using tools with small diameter.
- Do not rotate the machine spindle while the AIR TURBINE SPINDLE mounted into the machine spindle.
- ※ It is not a problem to rotate the machine's spindle for the orientation at the moment of the ATC.

3 Installation of the manual type

! WARNING

Be sure to stop the rotation.

When using the AIR TURBINE SPINDLE, it is not necessary to fix it using an anti-rotation bar, however, if the machine's spindle is rotated by mistake, this may twist the air tube causing severe accidents.

3-1 Anti-rotation bar installation

Insert, as shown in the figure on the right, the anti-rotation bar with its flat part facing up in the anti-rotation block and perform a side lock.

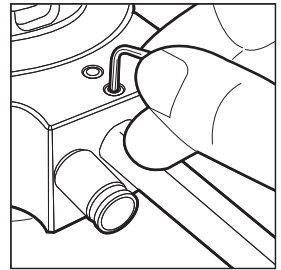
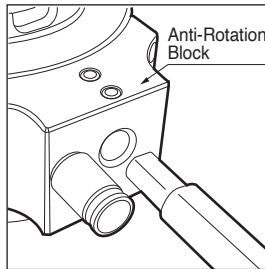

3-2 Installation on the machine

Make a "stop bar" and install it on the machine surface.

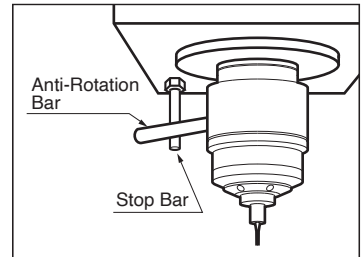

4 Concerning the air supply

Since the AIR TURBINE SPINDLE uses compressed air as driving source, if an air rich with moisture and foreign bodies is used, the bearings may rust or get stuck reducing the tool life. In order to use pure air, the following device is recommended. Even when using the center through type, always use a filter (mesh: 0.01mm or above) to supply pure air from the machine's spindle.

Air filter regulator (Model: XF1)

This device is necessary to remove foreign bodies from the air supplied to the spindle and to regulate the air pressure.

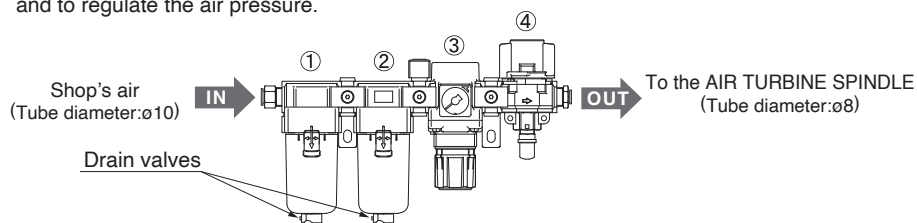

Number	Name	Function
①	Mist separator	Mesh: 0.3 μ m
②	Micro mist separator	Mesh: 0.01 μ m

Number	Name	Function
③	Regulator	Air pressure adjustment (spindle speed)
④	ON/OFF valve	Open/close the air (no-grease type)

⚠ CAUTIONS REGARDING THE INSTALLATION AND THE PLUMBING

- ※ Do not use air that contains large quantities of drain (moisture, oil, dust).
- ※ Install the device vertically in order to have the drain valves pointing downward.
- ※ Arrange enough space under the “Air filter regulator” for changing the elements and for draining.
- ※ Before doing the plumbing, clean the tubes removing chips, coolants and foreign bodies.
- ※ Prevent tensional and bending moments on the “Air filter regulator” other than its own weight. (Pay attention in particular when using pipes like steel pipes, etc., that do not have flexibility.)

⚠ CAUTIONS REGARDING THE MAINTENANCE

- ※ Before using the device always check the amount of drain inside the regulator and the dirt of the plastic cases. If the plastic cases are very dirty clean them using a neutral detergent.
- ※ Replace the filter elements ① and ② with new ones after 2 years of use or if the air pressure is lower than 0.1MPa. (Consult P18 Element replacement)

[Element replacement]

In case of not being able to drain a great volume due to low pressure, the element of the (micro) mist separator is stuck. Replace the element assembly (sold apart) following the below procedures.



WARNING

Before replacing the elements always check that there is no pressure inside the device.

Procedures

《Disassembly》

① Case assembly removal

Push down the lock button while pulling up the case assembly and then rotate it in one direction for 45° to remove it.

② Element removal

Apply round pincers to the cylindrical part of the element and turn them to the left for removing the element.

《Assembly》

③ Element installation

Apply round pincers to the cylindrical part of the element and turn them to the right for installing the element.

Clamping torque 0.35 ± 0.05 [N·m]

④ Case assembly installation

Insert the case assembly in the body assembly aligning the respective line markers and then rotate it in one direction for 45° (until the lock button slides up) to mount the case assembly.

Be sure to check that the lock button is in the upper position.

【Mist separator assembly drawing】

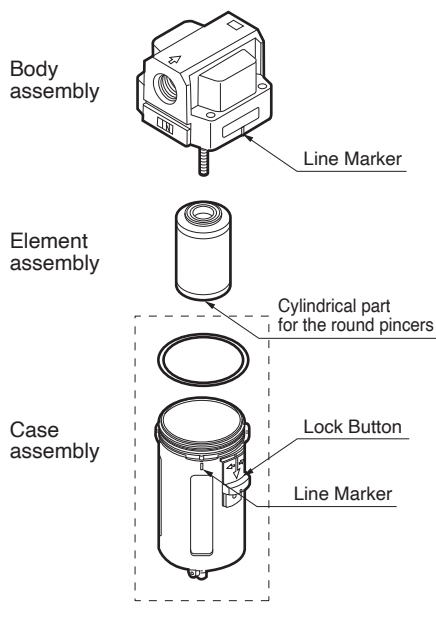

WARNING

After have done the replacement work, please always check that there are no external leaks and that the functions are adequate before carrying out the installation.

1 Long period storage and re-use

● In case of storing the device for a long period of time

- Protect the air inlet so that foreign bodies, dust, etc. do not penetrate.
- Apply anti-rust oil on the internal and external diameters of the chuck and on the taper shank.



CAUTION

Do not apply the anti-rust oil on the body (muffler case, locating pin, etc.) of the unit.
The oil invading the unit may lower the life of the bearings.

● In case of re-use the unit after a long period of storage

- Check that the pull-stud bolts, the internal and external diameters of the chuck and the taper shank are not affected by rust.
- Remove completely the anti-rust oil.
- Before connecting the air tube to the unit, release the air to check that moisture, etc. is not present inside the tube.
- Perform a warming-up operation.

2 Maintenance

● Greasing

It is not necessary to oil the internal parts of the unit. We will grease the unit when doing the overhaul.

● Disassembly and modifications

Never disassemble or modify the unit. Otherwise, it will be considered outside the normal overhaul or repairs.

● Overhaul

It is recommended to perform the overhaul after 1 year from the first operation or when the operation time exceeds 2000 hours. The overhaul is also recommended if the unit is not used for a long period of time (1 year or more). Return the unit through our distributors for the overhaul. The overhaul is charged.

● In case of strange noises, nasty smells and vibrations

Stop immediately the operation and contact us in case of strange noises and nasty smells coming from the AIR TURBINE SPINDLE or in case of strong vibrations.

In addition do not continue to operate with strong vibrations (chattering process).



BIG DAISHOWA SEIKI CO., LTD.

■ EXPORT DEPARTMENT

TEL : (+81)-72-982-8277

E-mail : export@big-daishowa.co.jp